

OAK ROUND MEDIUM AC SPEC SHEET



OAK-R-M-AC



Our OAK series LED spotlight fixtures are a simple, yet elegant solution for architectural spot and accent luminaire. Available with three optic configurations (Narrow, Medium & Wide). The luminaire is capable of withstanding extreme outdoor conditions with a chemically sealed glass lens and proprietary moisture barriers.

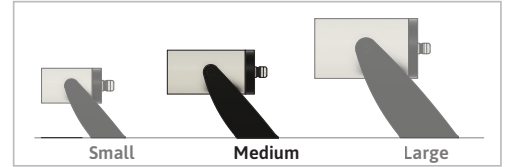

SPECIFICATION

OPERATING VOLTAGE	100 - 264 VAC
OPERATING TEMPERATURE	-20°C to + 50°C
CRI	80
INPUT CURRENT @115 VAC, 60Hz	180 mA
INPUT CURRENT @230 VAC, 50Hz	100 mA
NO OF LED	1
LED TYPE	COB
LIGHT SOURCE	Cree
COLOR RANGE	2200K / 2700K / 3000K / 4000K
PROJECTION	Narrow, Medium, Wide
FIXTURE CONNECTION	Pigtail
AVAILABLE IP RATING	IP66



DELIVERED LUMENS BY CCT

White	Lumens (10W)
2200K	750 lm
2700K	900 lm
3000K	940 lm
4000K	990 lm

Application

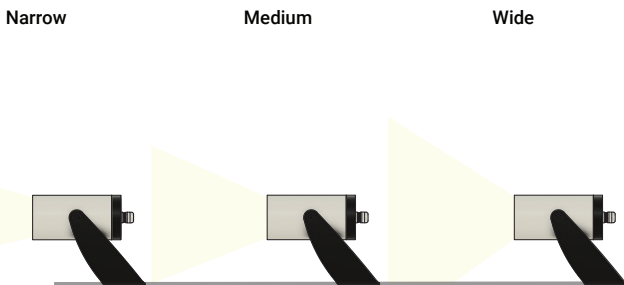
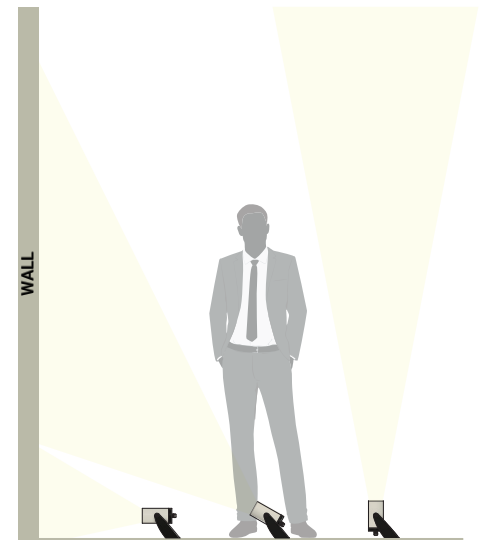

180° Angle Swivel Base

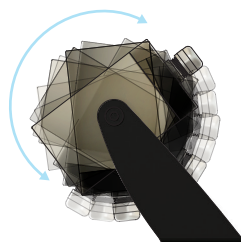

Honeycomb Louver (Optional)



OAK ROUND MEDIUM AC SPEC SHEET

OAK-R-M-AC



ORDERING CODE

PRODUCT SERIES	TYPE	SIZE	POWER	COLOR TEMPERATURE	PROJECTION	MOUNTING	VOLTAGE	ACCESSORIES
OAK	R - ROUND	M - MEDIUM	7W - 7WATTS 10W - 10WATTS	CT 22 - 2200K CT 27 - 2700K CT 30 - 3000K CT 40 - 4000K	NB - NARROW MB - MEDIUM WB - WIDE	SM - SURFACE MOUNT SP - SPIKE MOUNT	AC - 100-264VAC	N - NONE H - HONEYCOMB

FITURE FINISHING	
BODY FINISH	TRIM FINISH
BWH - WHITE	TWH - WHITE
BBL - BLACK	TBL - BLACK
BSL - SILVER	TSL - SILVER
BCM - CUSTOM	TGL - GOLD
	TCM - CUSTOM

Sample: OAK-R-M-10W-CT22-NB-SM-AC-H-BWH-TBL

DIMENSIONS

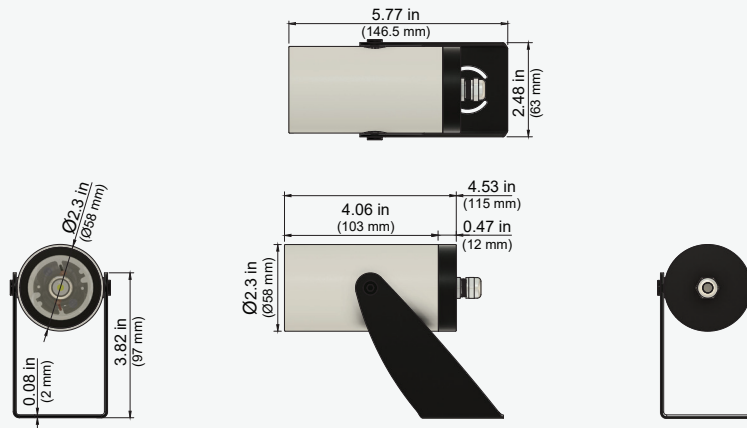

PHOTOMETRIC DATA

Polar Curve

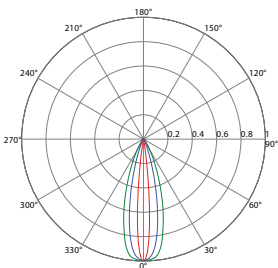

BIN Details (CIE 1931)

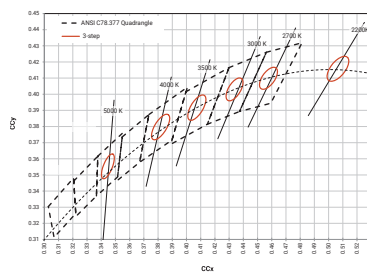

Spectral Radiant Flux VS Wavelength

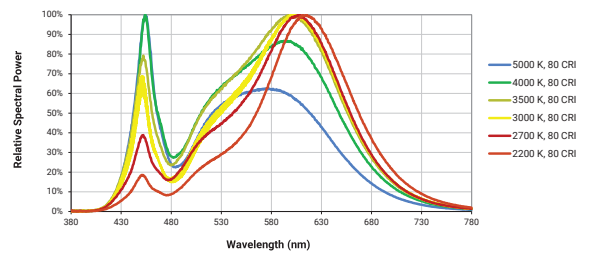

RELATED PRODUCTS

Spike Mount



OAK - Round Medium - DC

