

OAK ROUND LARGE AC SPEC SHEET



OAK-R-L-AC



Our OAK series LED spotlight fixtures are a simple, yet elegant solution for architectural spot and accent luminaire. Available with three optic configurations (Narrow, Medium & Wide). The luminaire is capable of withstanding extreme outdoor conditions with a chemically sealed glass lens and proprietary moisture barriers.

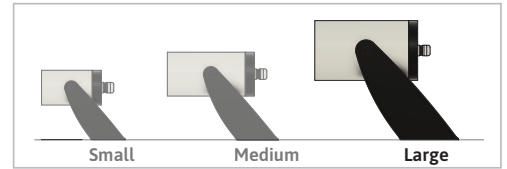

SPECIFICATION

OPERATING VOLTAGE	100 - 264 VAC
OPERATING TEMPERATURE	-20°C to + 50°C
CRI	80
INPUT CURRENT @115 VAC, 60Hz	190 mA
INPUT CURRENT @230 VAC, 50Hz	95 mA
NO OF LED	1
LED TYPE	COB
LIGHT SOURCE	Cree
COLOR RANGE	2200K / 2700K / 3000K / 3500K / 4000K / 5000K
PROJECTION	Narrow, Medium, Wide
FIXTURE CONNECTION	Pigtail
AVAILABLE IP RATING	IP66



DELIVERED LUMENS BY CCT

White	Lumens (20W)
2200K	1480 lm
2700K	1710 lm
3000K	1830 lm
3500K	1830 lm
4000K	1790 lm
5000K	1790 lm

Application

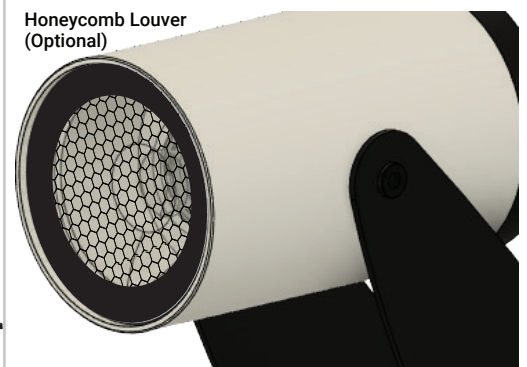
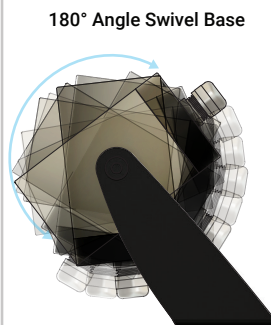
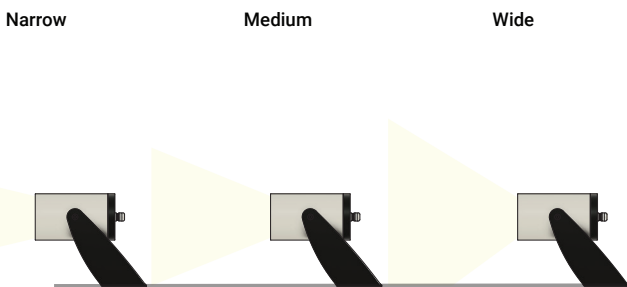
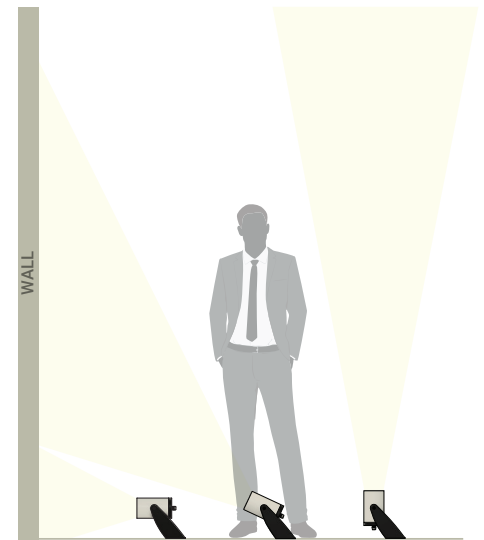

OAK ROUND LARGE AC SPEC SHEET

OAK-R-L-AC



ORDERING CODE

PRODUCT SERIES	TYPE	SIZE	POWER	COLOR TEMPERATURE	PROJECTION	MOUNTING	VOLTAGE	ACCESSORIES
OAK	R - ROUND	L - LARGE	15W - 15WATTS	CT 22 - 2200K	NB - NARROW	SM - SURFACE MOUNT	AC - 100-264VAC	N - NONE
			20W - 20WATTS	CT 27 - 2700K	MB - MEDIUM	SP - SPIKE MOUNT		H - HONEYCOMB
				CT 30 - 3000K	WB - WIDE			
				CT 35 - 3500K				
				CT 40 - 4000K				
			CT 50 - 5000K					

FITURE FINISHING	
BODY FINISH	TRIM FINISH
BWH - WHITE	TWH - WHITE
BBL - BLACK	TBL - BLACK
BSL - SILVER	TSL - SILVER
BCM - CUSTOM	TGL - GOLD
	TCM - CUSTOM

Sample: OAK-R-L-20W-CT22-NB-SM-AC-H-BWH-TBL

DIMENSIONS

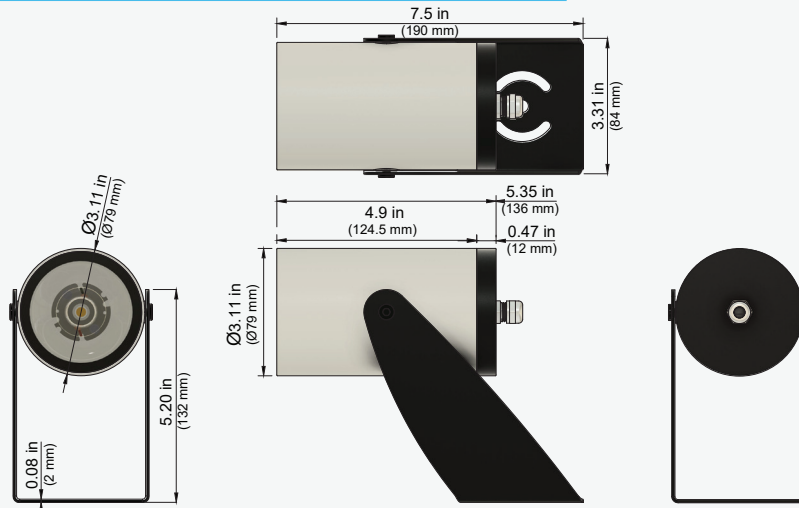

PHOTOMETRIC DATA

Polar Curve

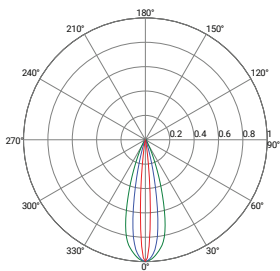

BIN Details (CIE 1931)

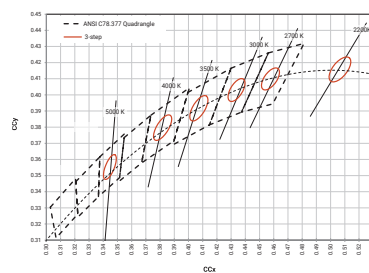

Spectral Radiant Flux VS Wavelength

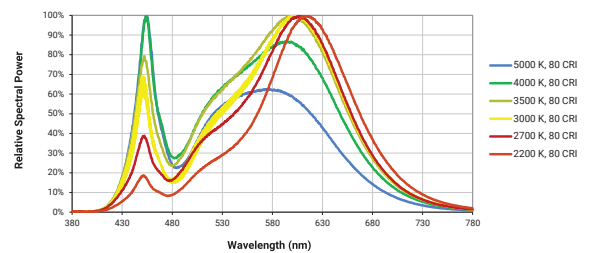

RELATED PRODUCTS

Spike Mount

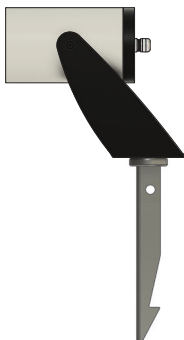

OAK - Square Large - DC

